

3D PDF DATASHEET

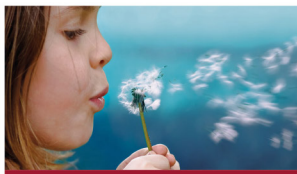

eCATALOG solutions



BIM catalogs.net



PARTsolutions



Create Your Individual 3D PDF Datasheet



Learn How to Create Your Mechanical Product Catalog



Learn How to Create Your BIM Product Catalog



Reduce Your Costs in Engineering and Purchasing



6309ZZE

NACHI

3D View

To activate the interactive 3D view, you must trust this document (see hint on the top) in Adobe Acrobat and click on the question mark.

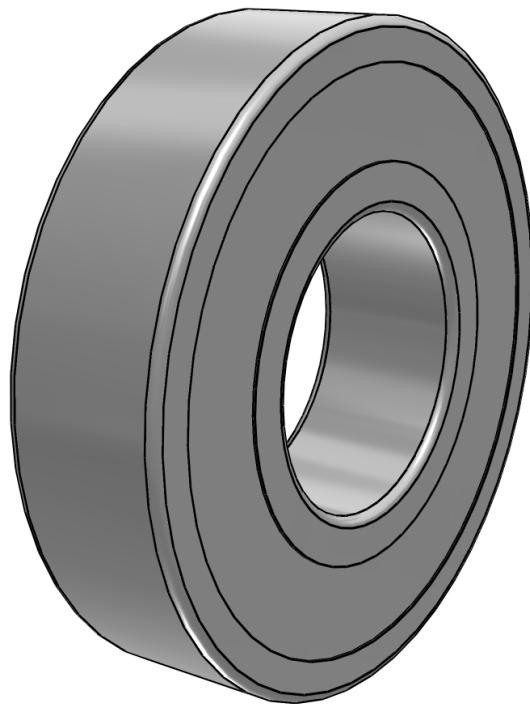

Zoom

Moves you toward or away from objects in the scene when you drag vertically. You can also zoom with the hand tool by holding down Shift as you drag.

Pan

Moves the model vertically and horizontally only. You can also pan with the hand tool: Ctrl-drag.

Rotate

Turns 3D objects around relative to the screen. How the objects move depends on the starting view, where you start dragging and the direction in which you drag.

3D PDF DATASHEET

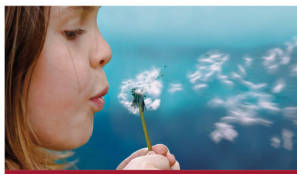

 eCATALOG solutions



 BIM catalogs.net



 PART solutions



Create Your Individual 3D PDF Datasheet 

Learn How to Create Your Mechanical Product Catalog 

Learn How to Create Your BIM Product Catalog 

Reduce Your Costs in Engineering and Purchasing 

6309ZZE

NACHI

2D derivation

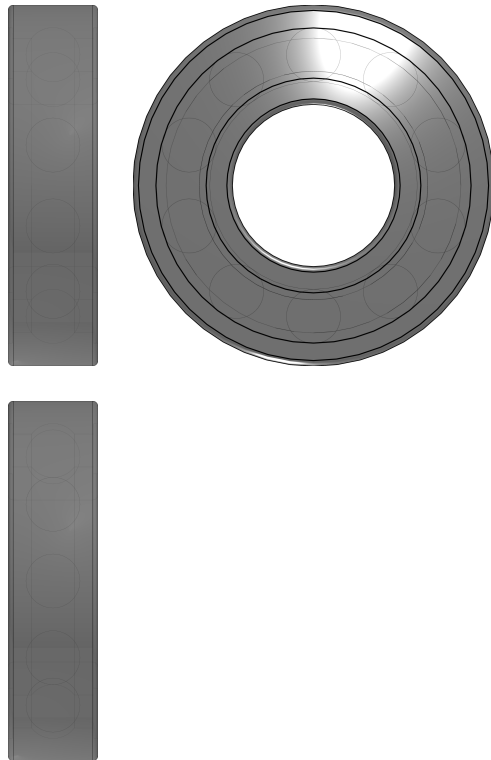

ISO View

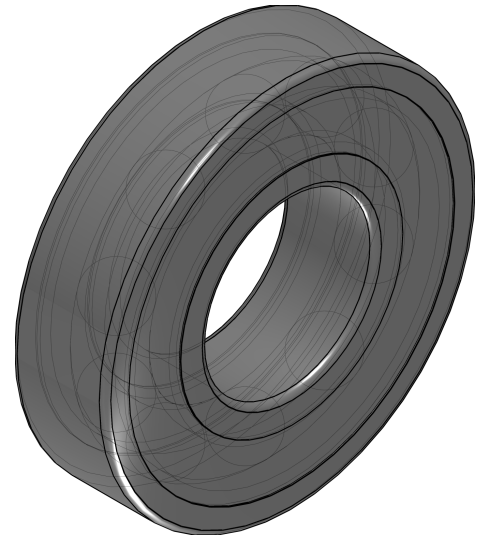



6309ZZE

NACHI

Technical drawings

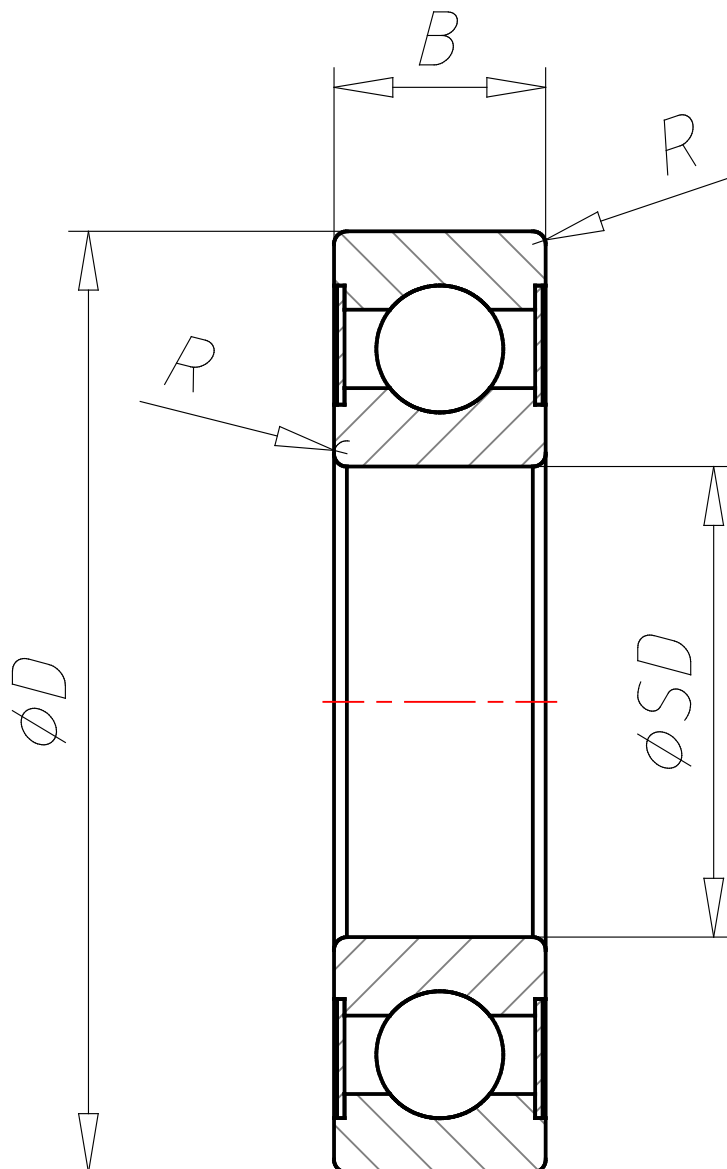

3D PDF DATASHEET

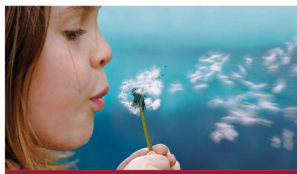

 eCATALOG solutions



 BIM catalogs.net



 PART solutions



Create Your Individual 3D PDF Datasheet 

Learn How to Create Your Mechanical Product Catalog 

Learn How to Create Your BIM Product Catalog 

Reduce Your Costs in Engineering and Purchasing 

6309ZZE

NACHI

Technical Data

SD (Inner dia. / mm)	45
D (Outer dia. / mm)	100
B (Width / mm)	25
R (Chamfer (min.) / mm)	1.5
BN (Bearing No.)	6309ZZE
CR (Basic dynamic load rating / N)	53000
COR (Basic static load rating / N)	32000
LSG (Permissible rotating speed (Grease) / min-1)	7000
MASS (Mass / kg)	0.833

3D PDF DATASHEET

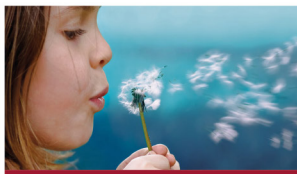

 eCATALOG solutions



 BIM catalogs.net





 PART solutions



Create Your Individual 3D PDF Datasheet 

Learn How to Create Your Mechanical Product Catalog 

Learn How to Create Your BIM Product Catalog 

Reduce Your Costs in Engineering and Purchasing 

6309ZZE

NACHI

Bill of Materials

N°	Description	Amount
1	6309ZZE	1